

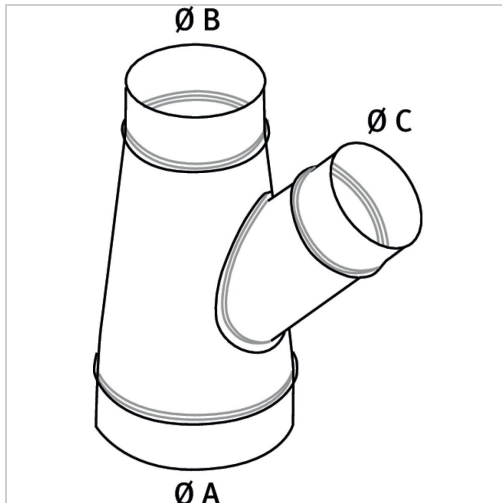

## Abzweigstück 45° Holzkraft Ø 180/120/120



**95,08 €\***

Preise inkl. MwSt. zzgl. Versandkosten

Artikelnummer: **ST5143717**

Dimensionen: **390x210x505**

Abgang 45°

**Hersteller**

Stürmer Maschinen GmbH

Dr.-Robert-Pfleger-Str. 26, 96103 Hallstadt, Deutschland

[info@stuermer-maschinen.de](mailto:info@stuermer-maschinen.de)

