

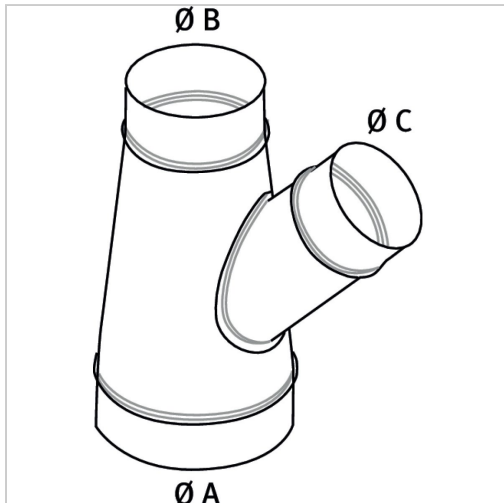

Abzweigstück 45° Holzkraft Ø 160/120/80



€106.92*

Prices incl. VAT plus shipping costs

Art nr.: **ST5143703**

Dimensionen: **170x290x405**

Abgang 45°

Hersteller

Stürmer Maschinen GmbH

Dr.-Robert-Pfleger-Str. 26, 96103 Hallstadt, Deutschland

info@stuermer-maschinen.de

