

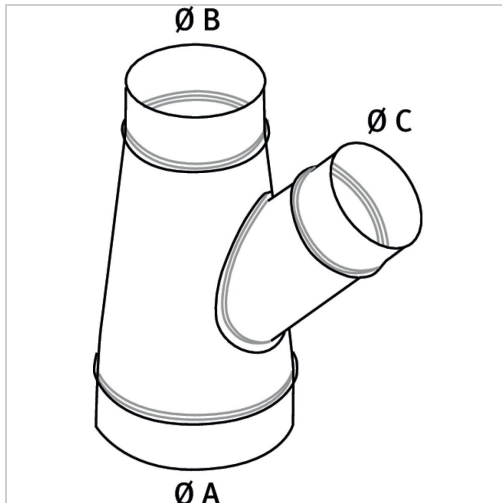

Abzweigstück 45° Holzkraft Ø 160/120/60



€106.98*

Prices incl. VAT plus shipping costs

Art nr.: **ST5143707**

Dimensionen: **410x260x171**

Abgang 45°

Hersteller

Stürmer Maschinen GmbH

Dr.-Robert-Pfleger-Str. 26, 96103 Hallstadt, Deutschland

info@stuermer-maschinen.de

